

super pintar
CALISTUNG

TRANSPORTASI

 **DARAT**  **LAUT**  **UDARA**

BONUS
Mewarnai

baca
tulis
hitung

TK & PAUD

Nurul Ihsan

GERAKAN INDONESIA MEMBACA



All Support by:



PESAN BUKU

WA/SMS: 0815 6148 165

inisiator by:



Sebaca Indonesia Foundation
"Berbagi Sejuta Buku Digital"

Jl. Raden Mochtar III No. 126
RT 003 RW 02, Kompleks Pos Giro
Sekebunar, Sindanglaya, Bandung 40195
Jawa Barat, Indonesia

Telp: (022) 87824898
WA: 08156148165

GERAKAN
INDONESIA
MEMBACA



Special Support by:



naskah
ilustrasi
komik
layout
desain





super pintar CaLiSTUNG

Naskah : Nurul Ihsan
Editing : Nurul Ihsan
Ilustrasi : Uci Ahmad Sanusi & Wawan Setiawan
Desain Cover : Yuyus Rusamsi
Penata Letak : Yuyus Rusamsi
Penerbit : cbmagency.com

Tim Kreatif
Creative Business Media
Jl. Raden Mochtar III No. 58
Komplek Pos Giro, Sindanglaya
Bandung, Jawa Barat 40195
Indonesia

Telp/Faks: +62 22 87824898

Hak cipta dilindungi undang-undang

Katalog Dalam Terbitan (KDT)



Ayo, hitung banyak bendanya kemudian
tulis jumlahnya serta tebakkan urutan
lambang bilangannya dari 1 - 10!



1

2

3

4

5

6

7

8

9

10



Tandai A untuk alat transportasi darat.
Tandai B untuk alat transportasi laut.
Tandai C untuk alat transportasi udara.

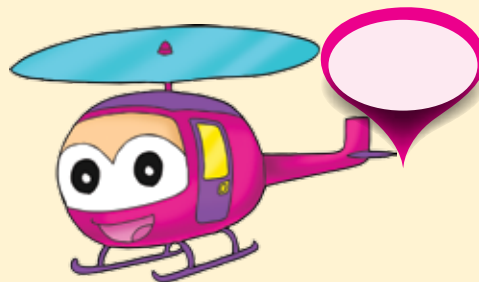
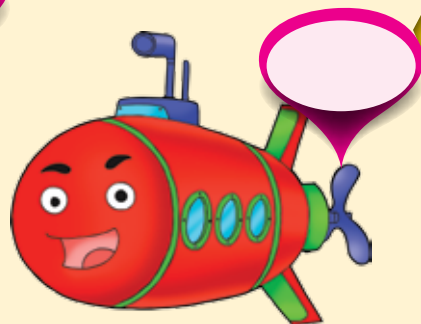
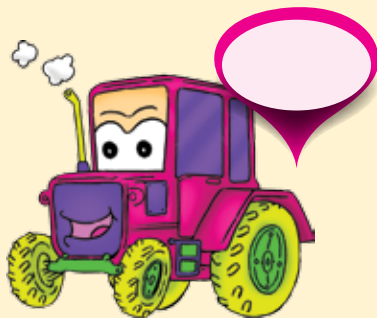
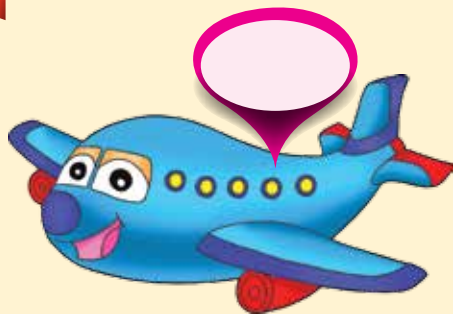



mobil balap

kapal selam

pesawat terbang

ada tiga alat transportasi yang bersahabat
yaitu



melaju kencang di arena balapan.
fnis paling depan.



pandai menyelam di laut dalam.
tidak takut tenggelam.



pandai terbang di angkasa.
membawa penumpang ke mana-mana.



Beri tanda silang (X) untuk kumpulan benda yang lebih banyak!

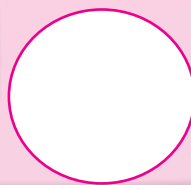
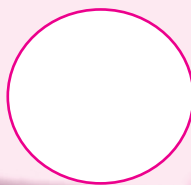
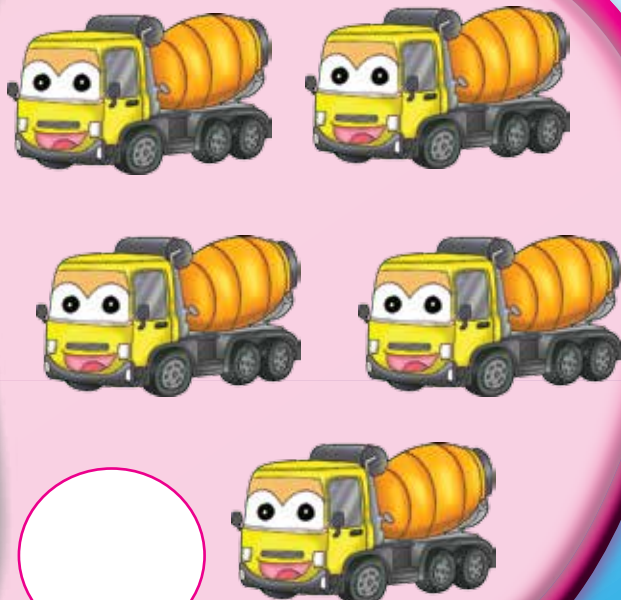
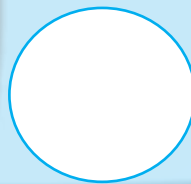
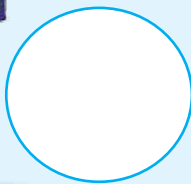
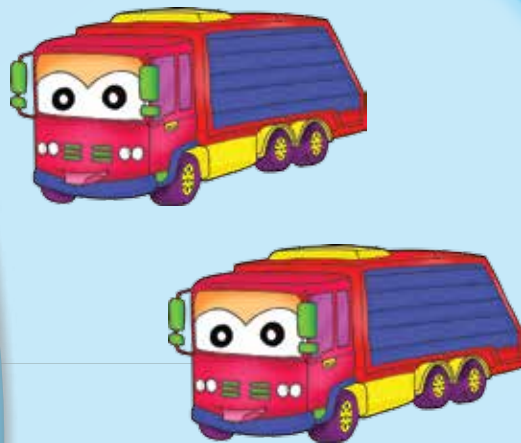

Copyright © All Rights Reserved/Penerbit: cbmagency.com

Naskah: Nurul Ihsan/Illustrasi: Uci Ahmad Sanusi/Desain Layout: Yuyus Rusamsi

Beri tanda silang (X) untuk kumpulan benda yang lebih sedikit!

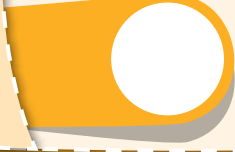
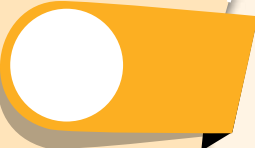
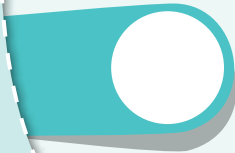
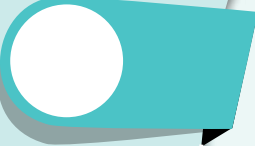

Copyright © All Rights Reserved/Penerbit: cbmagency.com

Naskah: Nurul Ihsan/Illustrasi: Uci Ahmad Sanusi/Desain Layout: Yuyus Rusamsi



Hitung setiap gambar di bawah ini kemudian
hubungkan gambar yang jumlahnya sama!

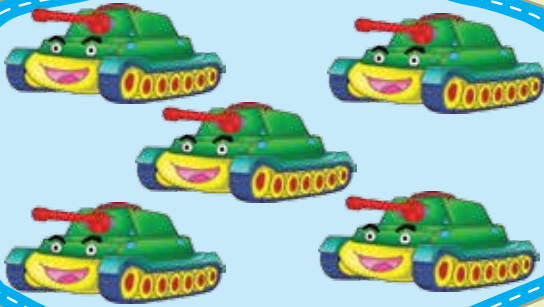

6



4

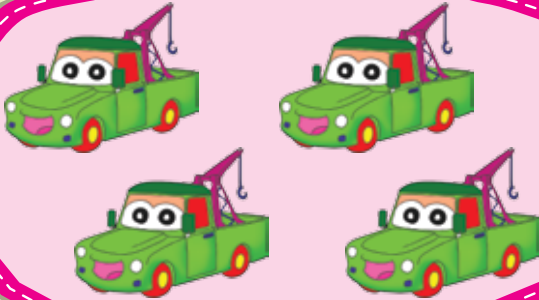

3



5

Hitung jumlah setiap gambar kemudian
lingkarilah lambang bilangan yang sesuai
dengan jumlah gambar!

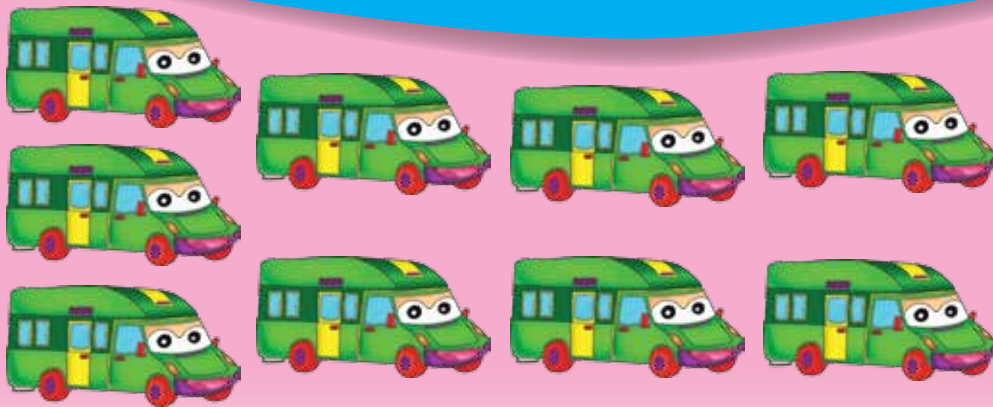

Copyright © All Rights Reserved/Penerbit: cbmagency.com

Naskah: Nurul Ihsan/Illustrasi: Uci Ahmad Sanusi/Desain Layout: Yuyus Rusamsi

Hitung jumlah gambarnya kemudian warnai kotaknya sesuai dengan jumlah gambar!







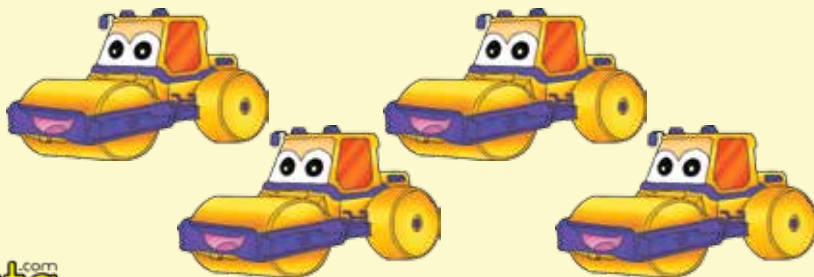

Copyright © All Rights Reserved/Penerbit: cbmagency.com

Naskah Nurul Ihsan/Iustrasi: Uci Ahmad Sanusi/Desain Layout: Yuyus Rusamsi

Hitung jumlah gambar dalam setiap kotak kemudian coret kelebihan gambar sesuai lambang bilangannya!

Copyright © All Rights Reserved/Penerbit: cbmagency.com

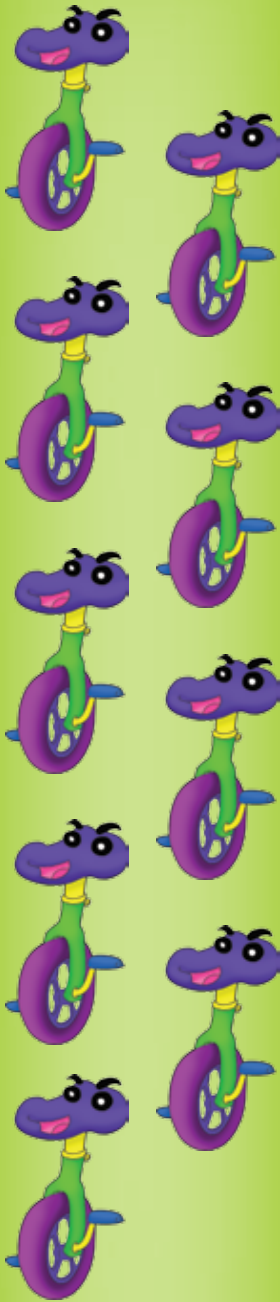

5



3



7

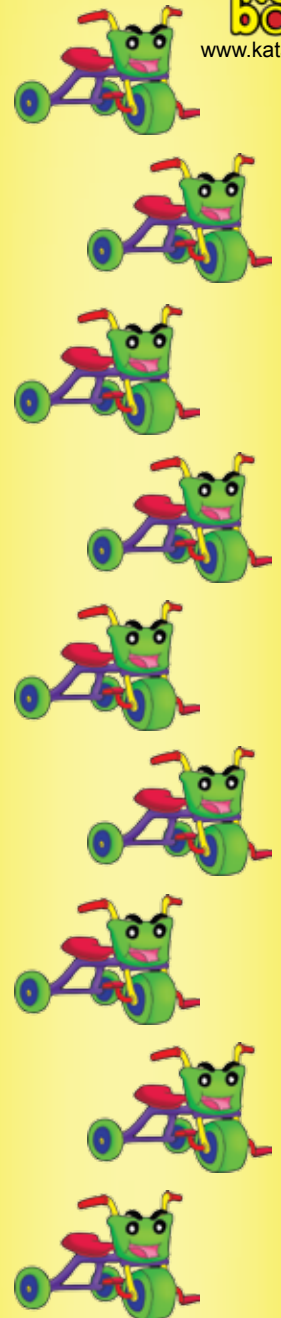

9

kata
baca
www.katabaca.com

Naskah: Nurul Ihsan/Illustrasi: Uci Ahmad Sanusi/Desain Layout: Yuyus Rusamsi

Beri tanda “sama dengan” (=) atau “tidak sama dengan” (≠) pada gambar berikut ini!

Copyright © All Rights Reserved/Penerbit: cbmagency.com



.....



.....

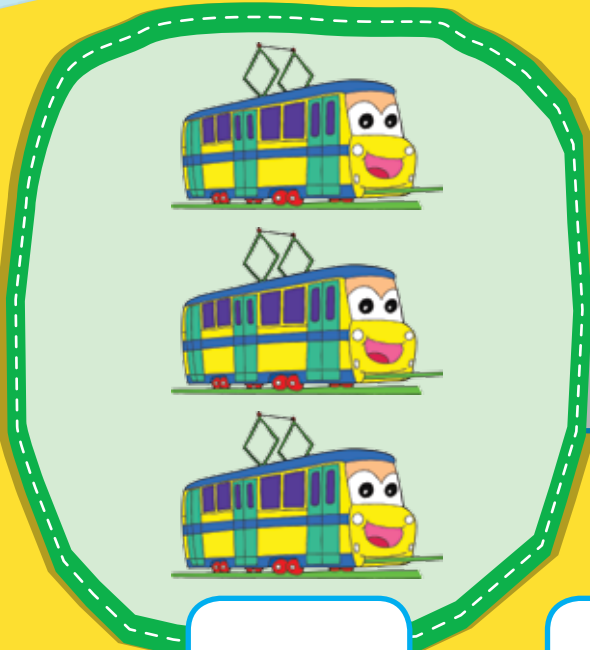

.....

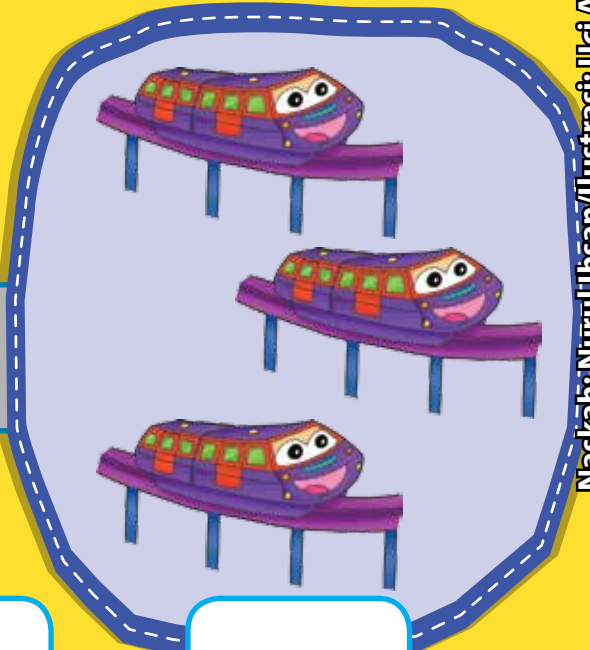

.....

Naskah: Nurul Ihsan/Iustrasi: Uci Ahmad Sanusi/Desain Layout: Yuyus Rusamsi

Warnai jawaban “**banyak**” atau “**sedikit**” pada kotak dengan benar!

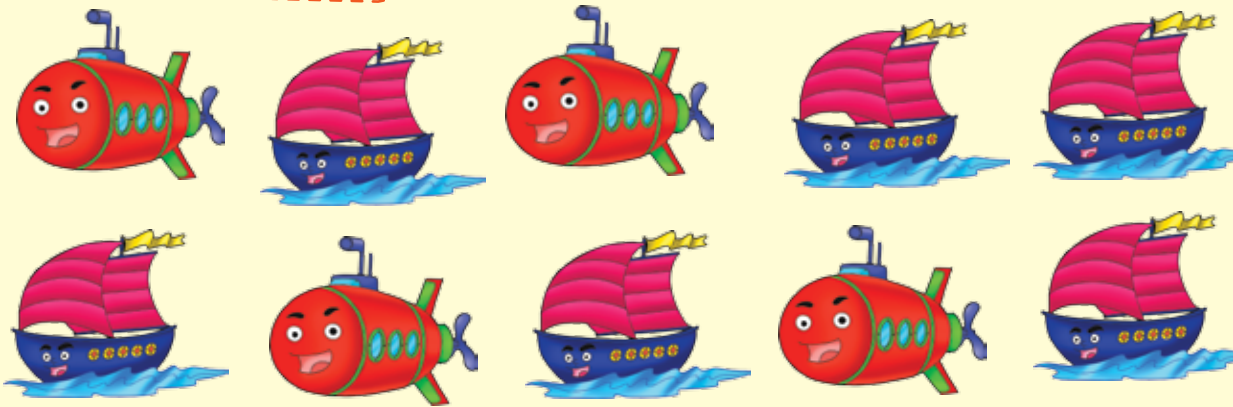

Gambar alat transportasi
atau lebih



lebih

banyak

sedikit

dari alat transportasi

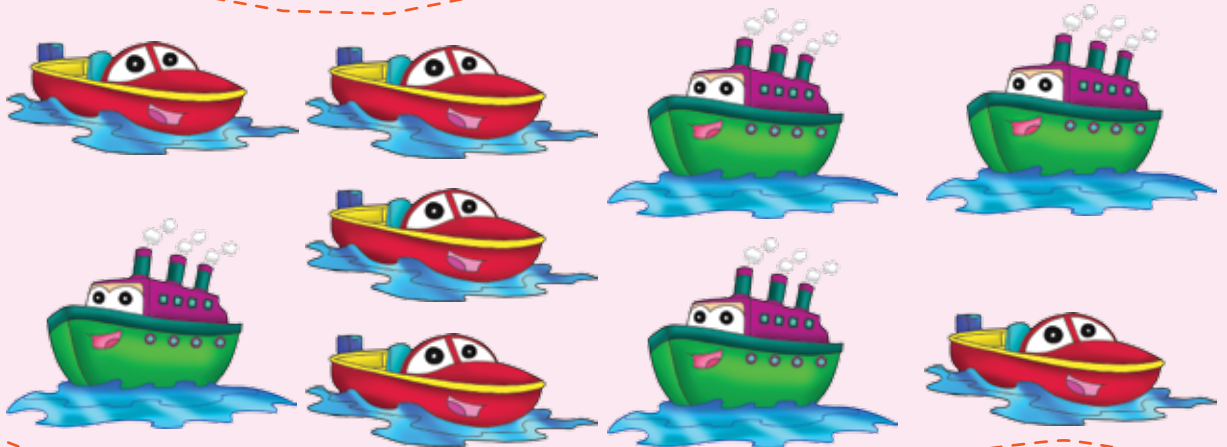

Gambar alat transportasi
atau lebih



lebih

banyak

sedikit

dari alat transportasi



Copyright © All Rights Reserved/Penerbit: cbmagency.com

Naskah: Nurul Ihsan/Illustrasi: Uci Ahmad Sanusi/Desain Layout: Yuyus Rusamsi



Beri tanda (v) pada kelompok gambar yang memiliki jumlah

6

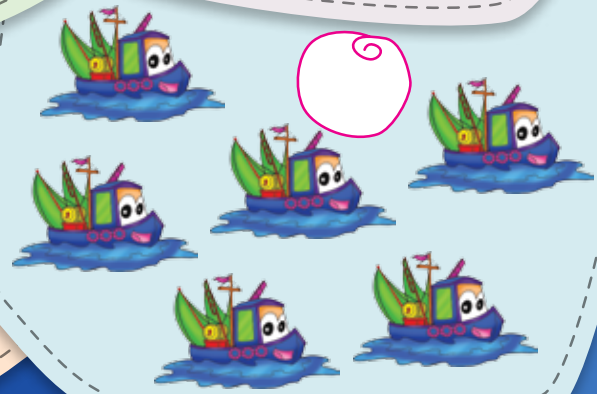
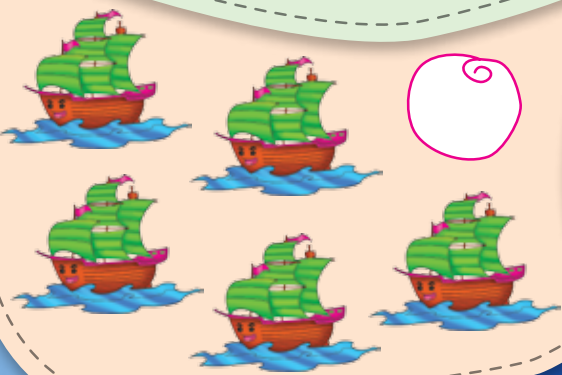
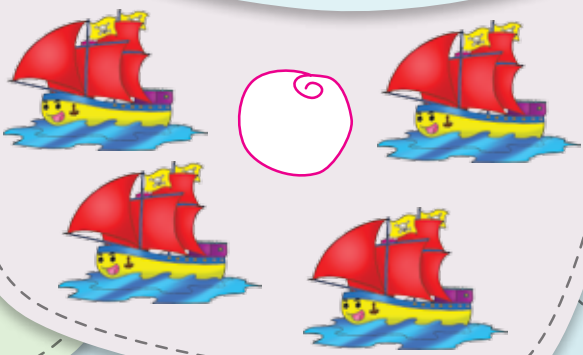
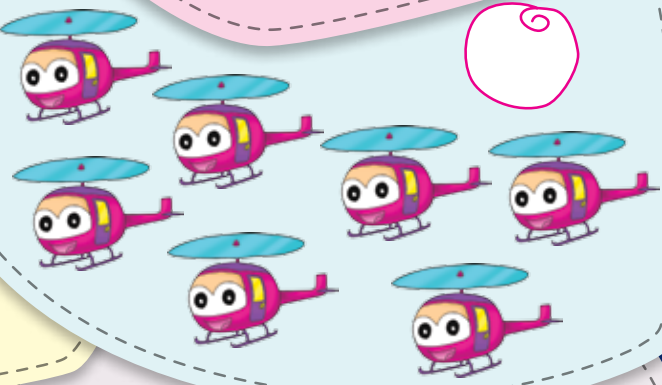
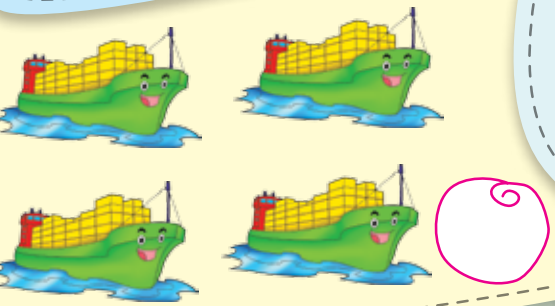
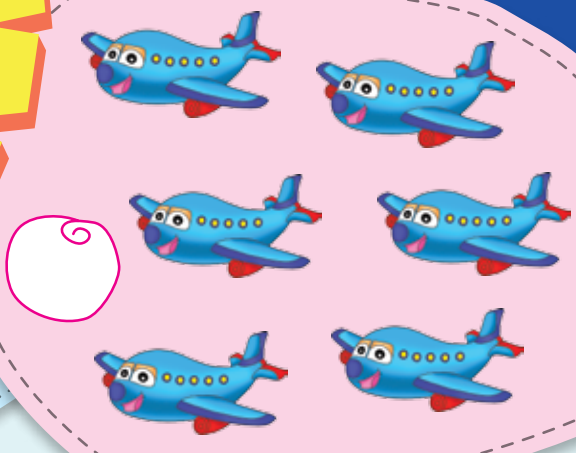
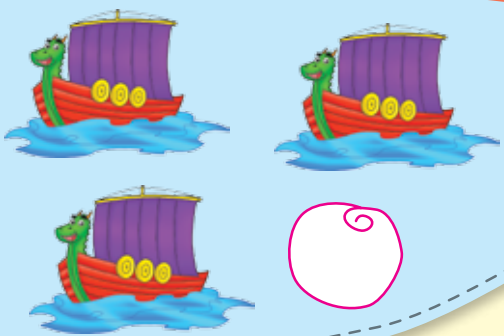

Copyright © All Rights Reserved/Penerbit: cbmagency.com

Naskah: Nurul Ihsan/Illustrasi: Uci Ahmad Sanusi/Desain Layout: Yuyus Rusamsi

Susun, lalu tuliskan huruf-hurufnya menjadi nama-nama transportasi sesuai dengan gambar!



t o r m o

--	--	--	--	--



n a m l a b u

--	--	--	--	--	--	--



d a s e p e

--	--	--	--	--	--	--



p i a e k r e a t

--	--	--	--	--	--	--	--

Copyright © All Rights Reserved/Penerbit: cbmagency.com

Naskah: Nurul Ihsan/Illustrasi: Uci Ahmad Sanusi/Desain Layout: Yuyus Rusamsi



Apa nama-nama transportasi di bawah ini?
Lingkari huruf yang ada di kotak untuk
menemukan jawabannya!



D	O	V	E	T
U	S	K	I	L
X	I	Z	P	A
O	W	L	Y	U

D	O	V	P	E
R	S	A	I	L
X	I	Z	N	G
O	W	L	H	U



D	H	E	U	T
J	S	L	I	Q
K	O	P	F	A
O	W	T	E	R

P	E	V	H	I
R	S	A	O	L
X	I	W	A	G
O	C	L	H	T

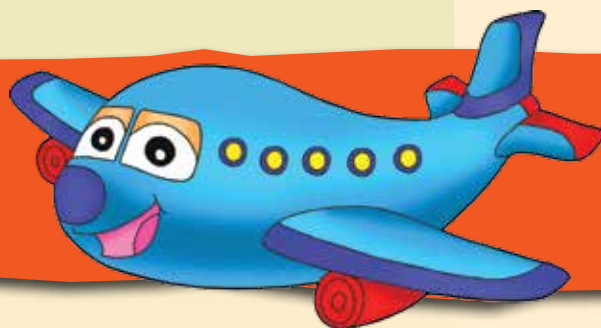

Copyright © All Rights Reserved/Penerbit: cbmagency.com

Naskah: Nurul Ihsan/Illustrasi: Uci Ahmad Sanusi/Desain Layout: Yuyus Rusamsi



Yuk, kita belajar Bahasa Inggris.
Caranya, tebalkan huruf-hurufnya hingga
menjadi kata dalam Bahasa Inggris!

t r a c k t o r



c a r



t r u c k



e s c a v a t o r



Carilah hurufnya, kemudian tuliskan nama transportasi sesuai dengan gambarnya!



t e s o
u a r b i k m
j

Four pink rectangular boxes with dotted lines for writing, corresponding to the letters above.



s i n t
a u b o
r k p l

Four light blue rectangular boxes with dotted lines for writing, corresponding to the letters above.



h m e n
o s w b
d l p i

Four light orange rectangular boxes with dotted lines for writing, corresponding to the letters above.

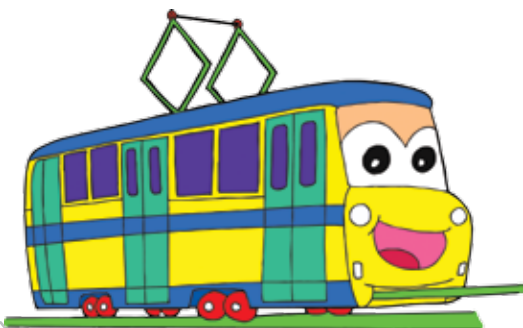

y t n i
e u o r v
z k r m

Four light green rectangular boxes with dotted lines for writing, corresponding to the letters above.

Teman-teman, yuk kamu bantu 4 alat transportasi menemukan nama-namanya.



Kapal
uap



Kapal
layar



Kapal
selam



Kapal
nelayan



Yuk kamu pasangkan dua huruf awalan nama-nama transportasi di bawah ini berdasarkan gambarnya!

mo



• sawat

pe



• lon

ka



• bil

ba



• pal

Coretlah yang bukan nama gambarnya!



UFO
HELIKOPTER
BALON
JET



KAPAL SELAM
PERAHU NAGA
KAPAL NELAYAN
KAPAL LAYAR



MOBIL ROTI
BIS SEKOLAH
MOBIL SURAT
MOBIL ES KRIM



Naskah: Nurul Ihsan/Illustrasi: Uci Ahmad Sanusi/Desain Layout: Yuyus Rusamsi

Copyright © All Rights Reserved/Penerbit: cbmagency.com



Lingkari yang bukan termasuk transportasi darat



Lingkari yang bukan termasuk transportasi laut



Copyright © All Rights Reserved/Penerbit: cbmagency.com

Naskah: Nurul Ihsan/Illustrasi: Uci Ahmad Sanusi/Desain Layout: Yuyus Rusamsi



Lingkari yang bukan termasuk transportasi udara

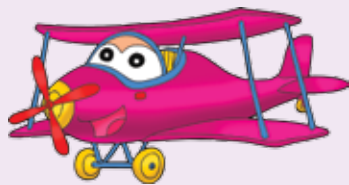

YUK, melingkari gambar dan angka. Hitunglah jumlah gambar alat transportasi. Lalu lingkari hasilnya pada kotak yang disediakan!

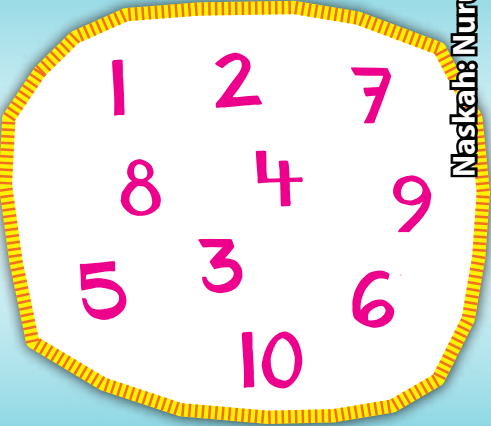
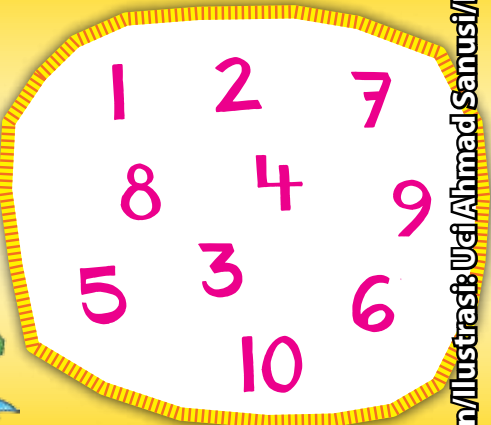
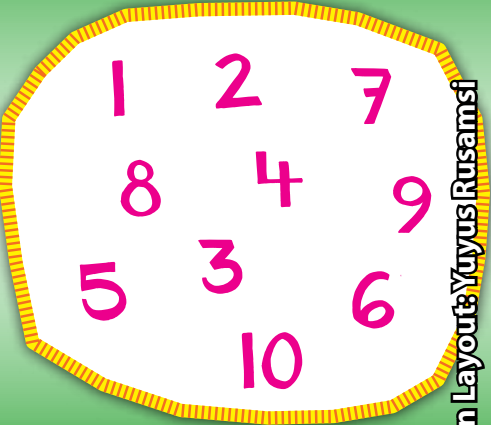

Copyright © All Rights Reserved/Penerbit: cbmagency.com

Naskah: Nurul Ihsan/Illustrasi: Uel Ahmad Sanusi/Desain Layout: Yuyus Rusamsi



Yuk, belajar kumpulan atau himpunan. Hitung jumlah alat transportasi dalam kotak, lalu beri tanda (√) gang jumlahnya paling banyak.



Copyright © All Rights Reserved/Penerbit: cbmagency.com

Naskah: Nurul Ihsan/Illustrasi: Uci Ahmad Sanusi/Desain Layout: Yuyus Rusamsi



Warnai alat transportasi di bawah ini.
Jumlah yang diwarnai sesuai dengan
lambang bilangan di sampingnya!

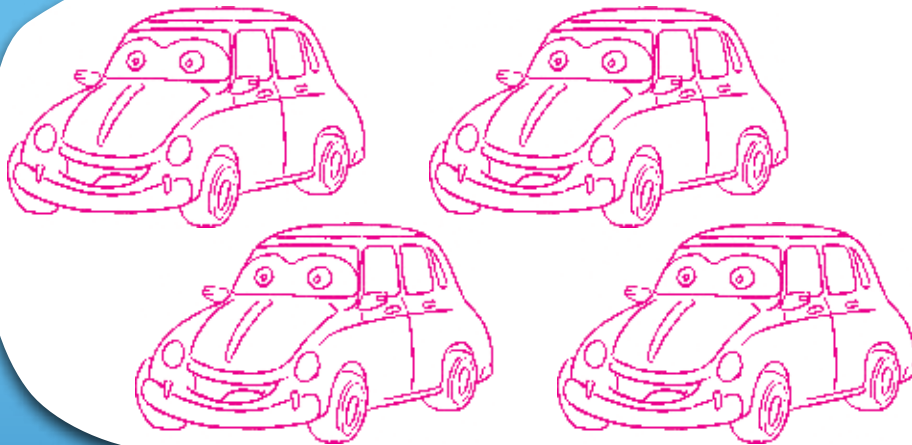

3

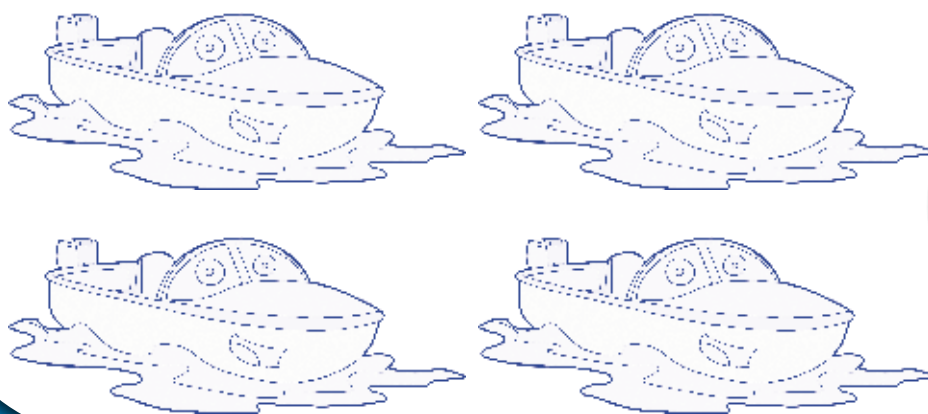

2

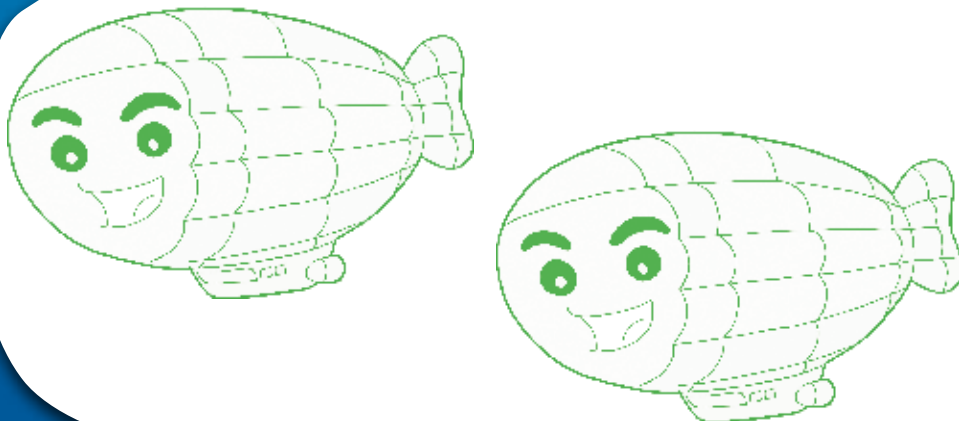

1



Yuk, mencari jejak. Pemadam kebakaran pergi ke sebuah rumah yang kebakaran. Yuk kamu tunjukkan jalannya dengan mewarnai jalannya mengikuti angka 5!

Copyright © All Rights Reserved/Penerbit: cbmagency.com

Naskah: Nurul Ihsan/Illustrasi: Uci Ahmad Sanusi/Desain Layout: Yuyus Rusamsi



Yuk, mengenal pecahan. Lingkari gambar alat transportasi yang menunjukkan dua bagian yang sama besar.

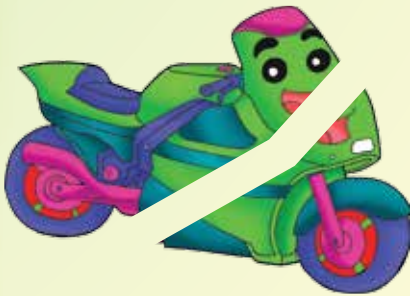
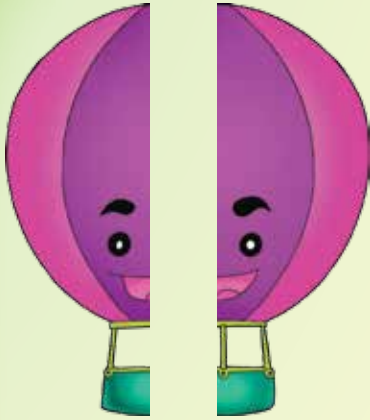

MENGENAL POSISI KANAN, KIRI, DAN TENGAH.

Lingkari alat transportasi yang berada paling kanan dari truk.



Lingkari alat transportasi yang berada paling kiri dari perahu naga.



Lingkari alat transportasi yang berada paling tengah.



Kalian suka pesawat terbang. Yuk, kita gambar pesawat terbang. Caranya, hubungkan titik-titik di bawah ini mulai dari angka 1 sampai dengan angka 20, kemudian warnailah!

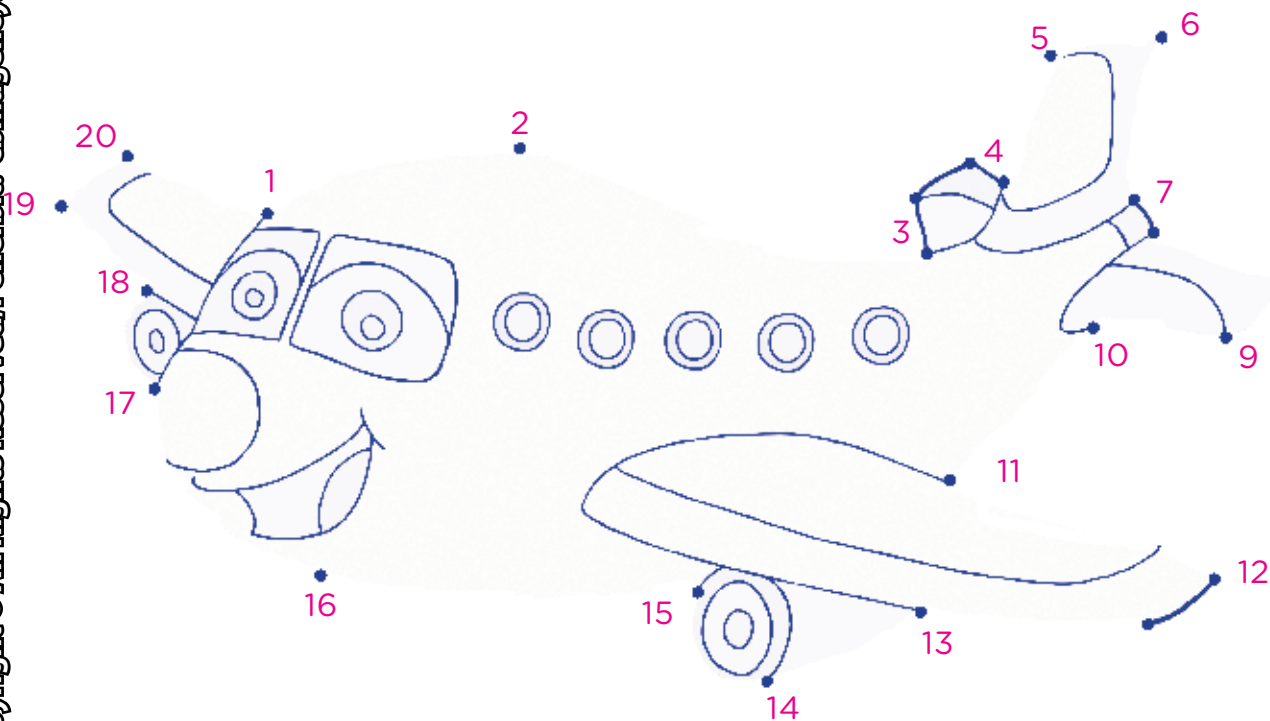

Copyright © All Rights Reserved/Penerbit: cbmagency.com

Naskah: Nurul Ihsan/Illustrasi: Uel Ahmad Sanusi/Desain Layout: Yuyus Rusamsi



Yuk Mewarnai



Aku pandai terbang. Aku punya baling-baling di atas kepalaku. Siapakah aku? Tebalkan namanya.

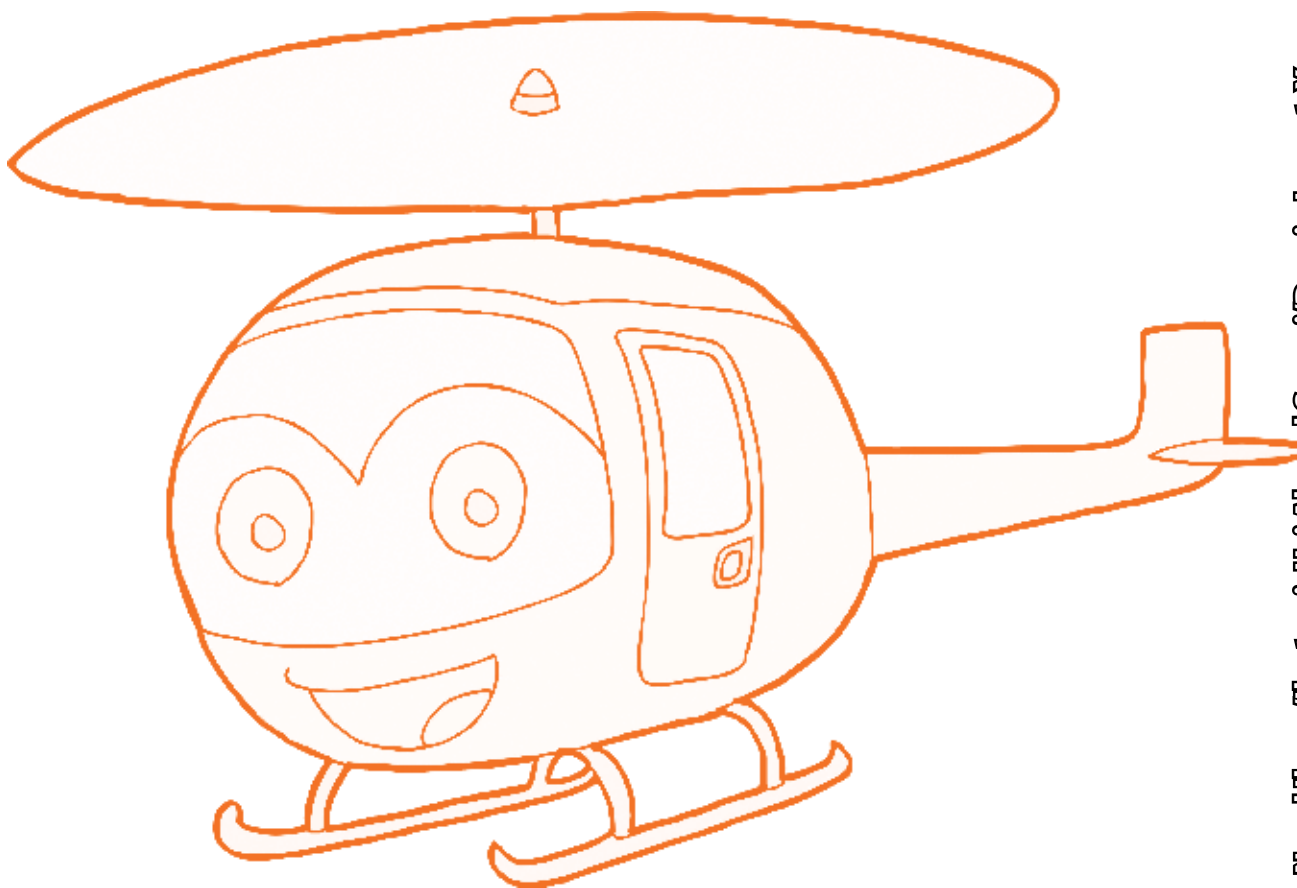

Copyright © All Rights Reserved/Penerbit: ebmagency.com

Naskah Nurul Ihsan/Iustrasi: Uci Ahmad Sanusi/Desain Layout: Yuyus Rusamsi

helikopter

Yuk Mewarnai

Tenagaku besar dan senang membantu. Aku siap menarik siapa saja mobil yang mogok di jalan. Siapakah aku? Tebalkan namanya.

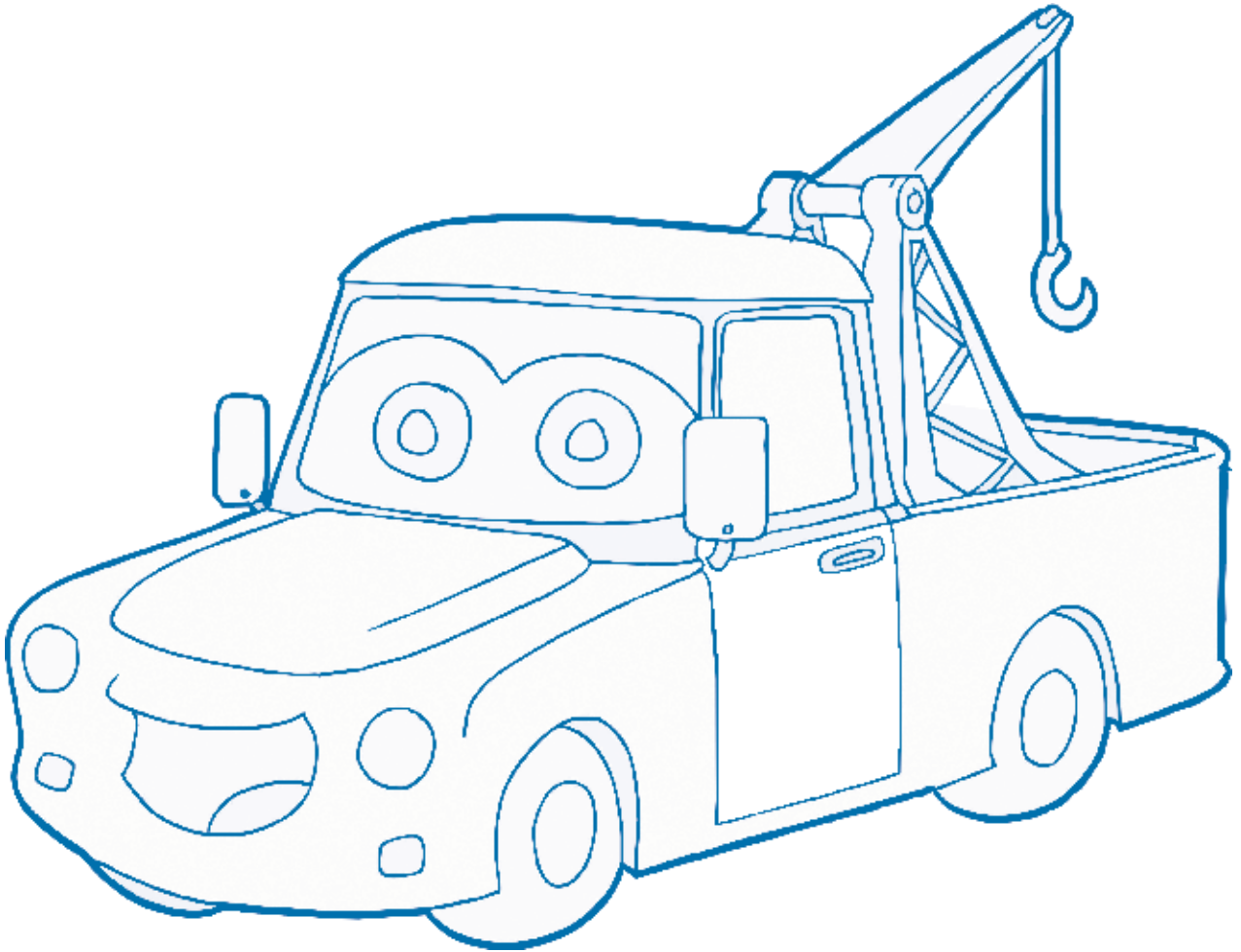

mobil derek



Yuk Mewarnai



Aku selalu menyelam di dalam air seperti ikan. Aku kapal pengintai. Siapakah aku? Tebakkan namanya.

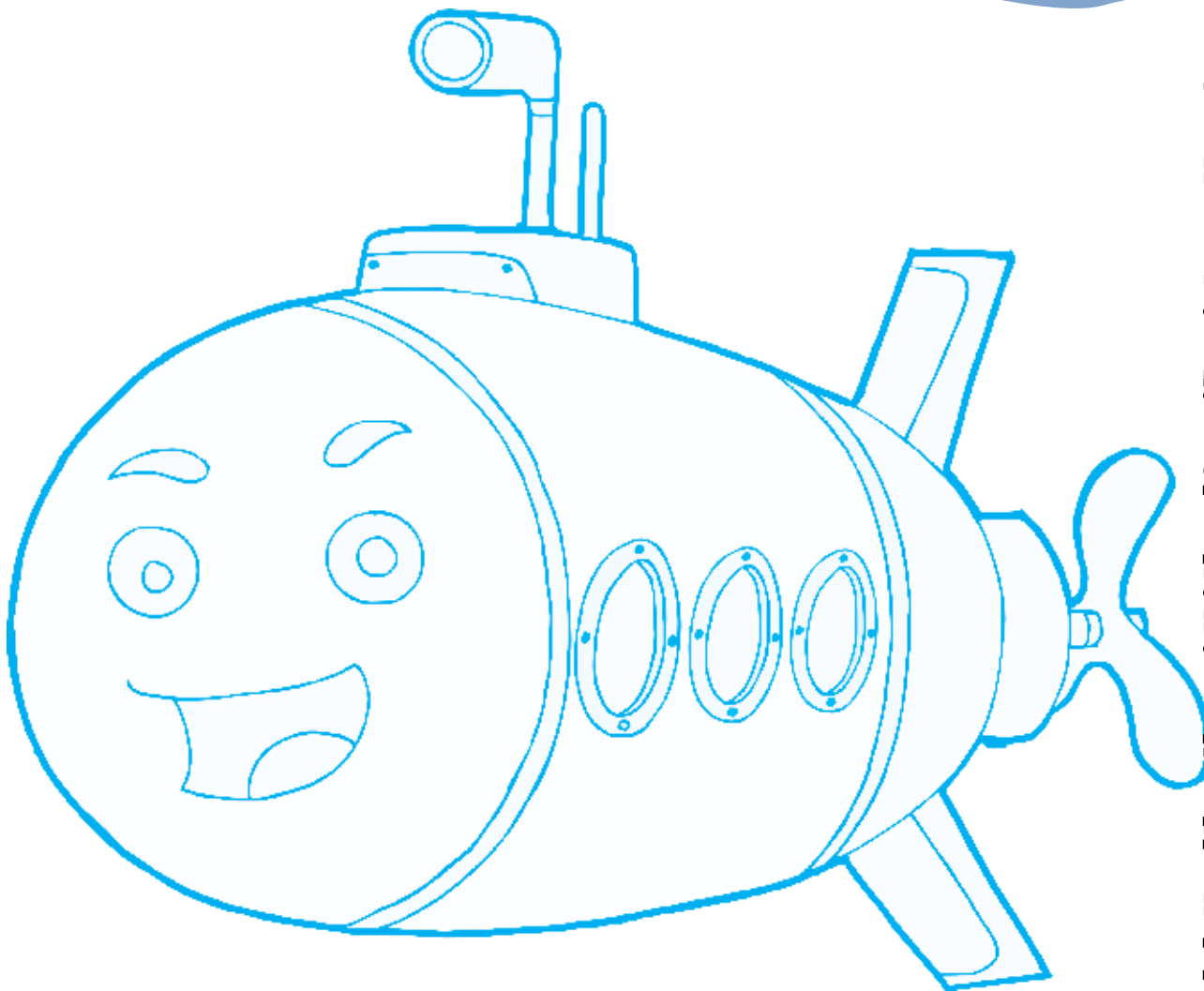

Copyright © All Rights Reserved/Penerbit: ebmagency.com

Naskah: Nurul Ihsan/Iustrasi: Uci Ahmad Sanusi/Desain Layout: Yuyus Rusamsi

kapal selam

Yuk Mewarnai



Aku sejenis kendaraan berat. Aku pandai mengeruk dan menggali tanah. Siapakah aku? Tebalkan namanya.

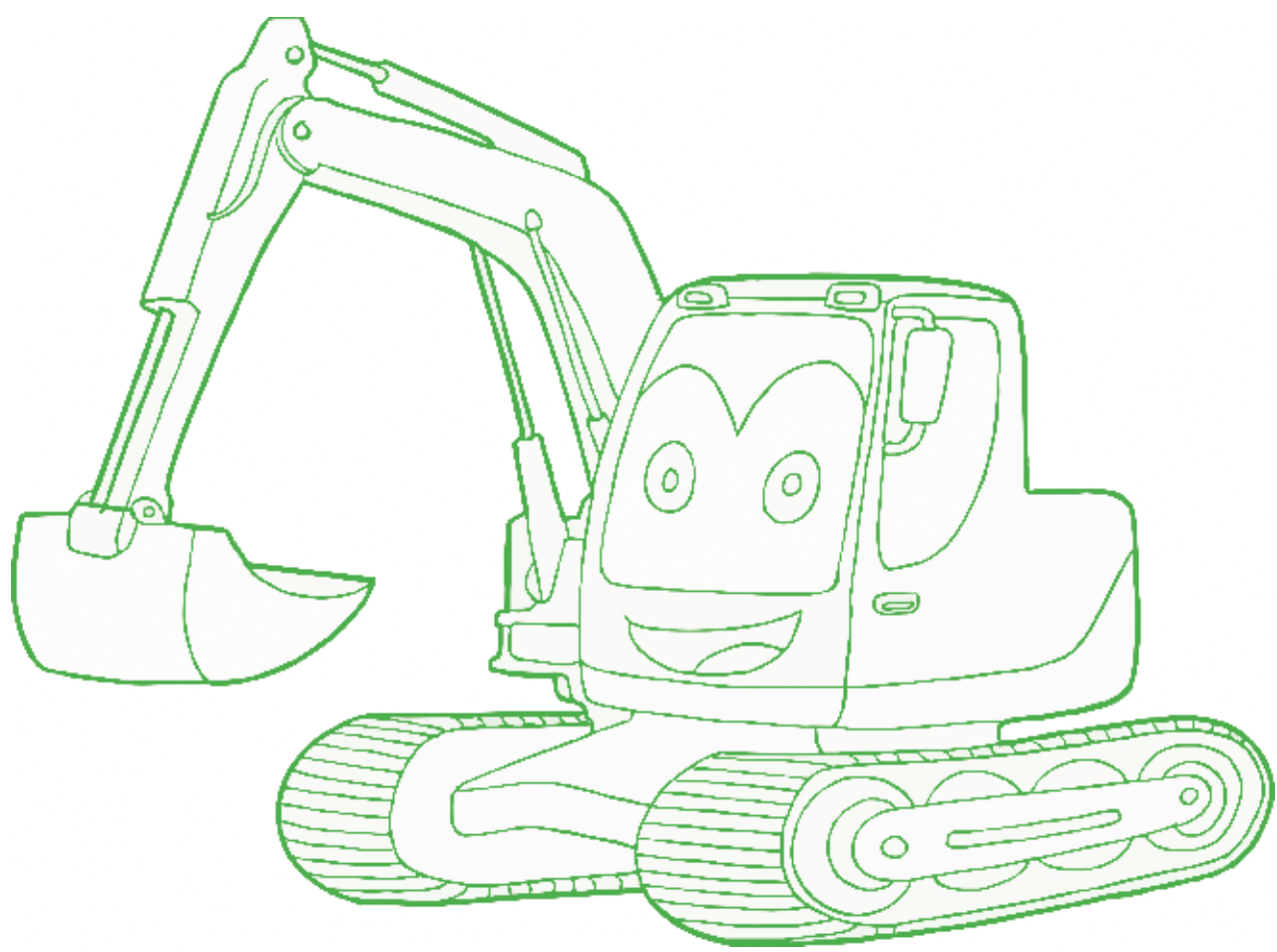

Copyright © All Rights Reserved/Penerbit: cbmagency.com

Naskah: Nurul Ihsan/Illustrasi: Uel Ahmad Sanusi/Desain Layout: Yuyus Rusamsi

eskavator

profil penulis



Penulis sudah terjun dan menggeluti dunia tulis menulis dan penerbitan sejak anak-anak. Hasil karya pertamanya sebuah cerita pendek (cerpen) pernah dimuat di Majalah SAHABAT PENA pada saat Penulis masih berusia 12 tahun. Maka tak heran, kalau dunia kepenulisan sejak lama sudah menjadi bagian tak terpisahkan dari sisi kehidupan Penulis. Selama perjalanan sebagai penulis dan ilustrator buku anak, beberapa penghargaan nasional di bidang penerbitan buku pernah berhasil diraihinya. Di antaranya beberapa kali meraih penghargaan Adikarya Ikatan Penerbit Indonesia (IKAPI).



Dalam banyak bukunya, Penulis biasa menggunakan beberapa nama pena dan nama tim. Setelah melewati masa lebih 10 tahun, sudah lebih 500 judul buku anak dan buku umum yang telah lahir dan pernah dibidannya bersama tim. Buku-buku tersebut sudah diterbitkan oleh sekian banyak penerbit nasional di Indonesia dan beberapa penerbit di luar negeri. Dari seluruh buku-buku tersebut, Penulis menjadi bagian yang tak terpisahkan sebagai konseptor, penulis, pengarang, penyunting, ilustrator, layouter, sampai desainer. Sejak 10 tahun silam, Penulis mendirikan dan mengelola **Creative Business Media** atau **cbmagency.com**, sebuah agen penyedia jasa copyright dan konten visual media penerbitan anak terlengkap di Indonesia.



CREATIVE BUSINESS MEDIA
publishing content services

🏠 Jl. Raden Mochtar III No. 58
Komplek Pos Giro,
Sindanglaya, Arcamanik,
Bandung 40195
Jawa Barat - Indonesia

☎ (+6221) 87824898
+62815 614 8165

✉ info@cbmagency.com
www.cbmagency.com

Salam kreatif

Nurul Ihsan

Founder & Owner cbmagency.com

